

INST-A-MATIC ASSEMBLY INSTRUCTIONS

Figure 1

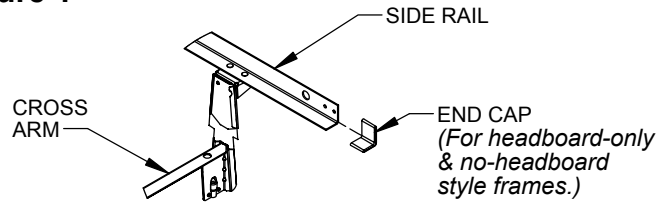

Step 1

Assemble CROSS ARMS to SIDE RAILS as shown in Figure 1.

Step 2 *For headboard-only and no-headboard style frames:*

Slide END CAPS onto SIDE RAILS. **Warning: End caps must be placed over ends of side rails to avoid serious injury.**

Step 3 *For 6-legged frames:*

Make sure CENTER LEG is positioned toward the middle of the bed as shown in Figure 2 and slide CENTER SUPPORT in place.

Step 4 *For 5-legged frames:*

Align one end of the CROSS SUPPORT with the slot in the center of one of the SIDE RAILS. Make sure that the SPRING CLIP snaps in place. Swing other end of CROSS SUPPORT until SPRING CLIP locks in place as detailed in Figure 3.

Step 5 *For frames with round center legs:*

Tap PLASTIC INSERT into ROUND LEG. Snap GLIDE BASE onto GLIDE EXTENSION. Tap glide assembly into PLASTIC INSERT. See Figure 4.

Step 6 *For frames with glides:*

Snap GLIDE BASE onto GLIDE EXTENSION. Install glide assembly as shown in Figure 5, making sure that the LEG fits into the notch on top of glide.

Step 7 *For frames with rollers:*

Install rollers as shown in Figure 6. Locking rollers, if provided should be placed on the corners at the foot of the bed.

WARNING: When attaching this frame to a headboard with narrow posts, it is recommended that any excess bolt be cut after attachment. See Figure 7.

Figure 2

(For 6-legged frames only.)

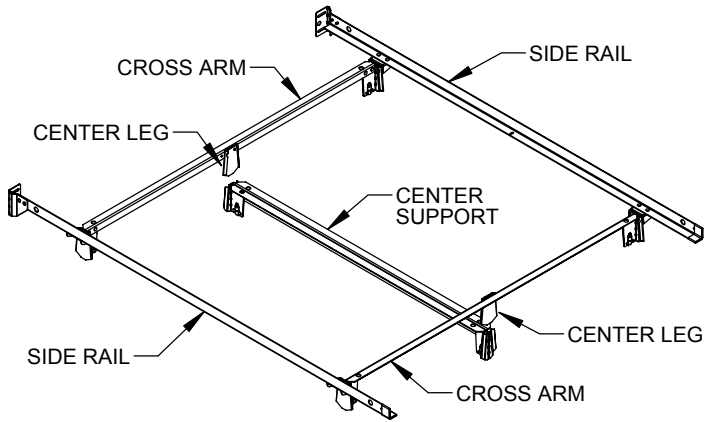

Figure 3

(For 5-legged frames only.)

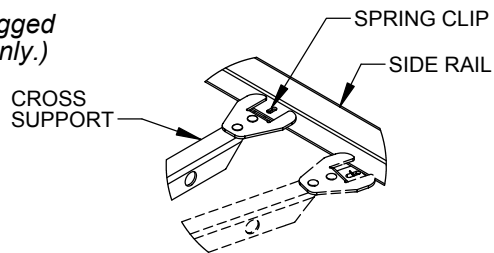

Figure 4

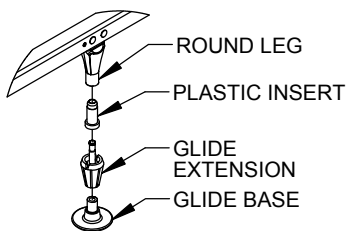

Figure 5

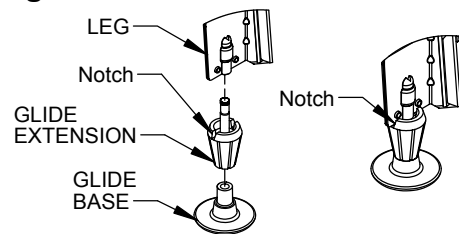

Figure 6

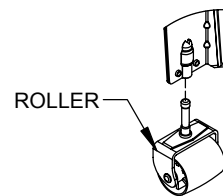
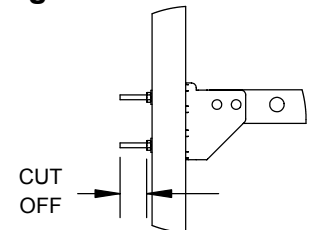

Figure 7



GL10 ASSEMBLY INSTRUCTIONS

For Inst-A-Matic Bedframes:

Step 1: Insert stem of GLIDE EXTENSION into leg of bedframe and place BASE onto GLIDE EXTENSION as shown in Figure 1.

Step 2: Make sure that the notch of the GLIDE EXTENSION is turned so that the leg of the bedframe is properly inserted as detailed in Figure 2.

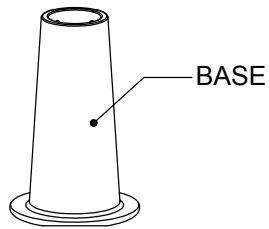
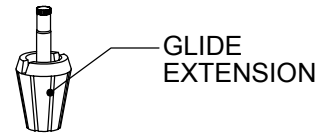
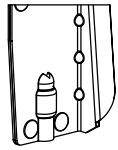

Figure 1

For standard bedframes:

Step 1: Tap PLASTIC INSERT into leg of bedframe. Insert stem of GLIDE EXTENSION into PLASTIC INSERT and place BASE onto GLIDE EXTENSION. See Figure 3.

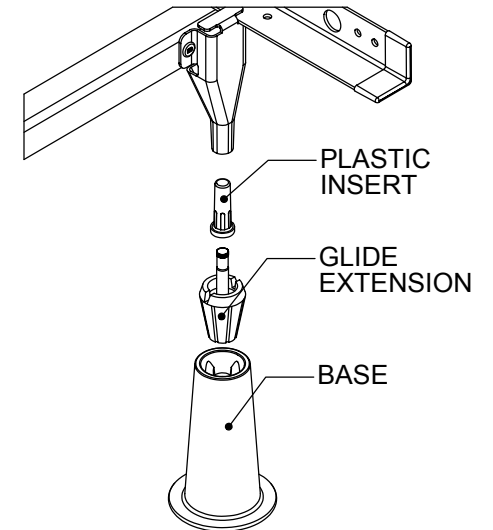

Figure 3

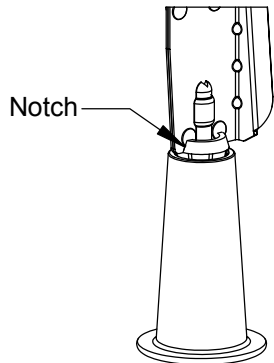

Figure 2